

M5 threaded stylus range

6.1



SP80 is an ultra-accurate quill-mounted scanning probe

Renishaw's probing systems are designed to give optimum performance using styli from its comprehensive range. The following probes all use M5 threaded styli, however, with suitable adaptors, other thread sizes may be used.

- SP80
- SP2
- SP2-1

Ruby micro ball styli (Tungsten carbide stems)

Part number		A-5003-5201	A-5003-5202	A-5003-5203
A	Ball dia. mm (in.)	0.3 (0.012)	0.5 (0.020)	0.7 (0.028)
B	Length mm (in.)	20.0 (0.79)	20.0 (0.79)	20.0 (0.79)
C	Stem dia. mm (in.)	0.2 (0.008)	0.4 (0.016)	0.5 (0.020)
D	EWL* mm (in.)	3.0 (0.12)	4.0 (0.16)	5.0 (0.20)
	Mass grammes	6.5	6.5	6.5

20 mm range

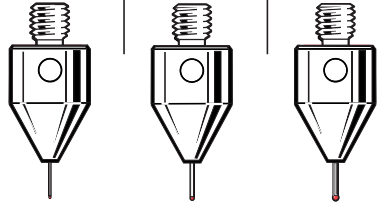

A-5003-5211	A-5003-5212	A-5003-5213
0.3 (0.012)	0.5 (0.020)	0.7 (0.028)
30.0 (1.19)	30.0 (1.19)	30.0 (1.19)
0.2 (0.008)	0.4 (0.016)	0.5 (0.020)
3.0 (0.12)	4.0 (0.16)	5.0 (0.20)
8.95	8.95	8.98

30 mm range

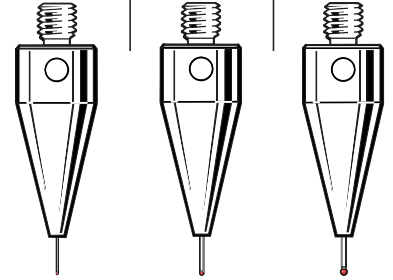

Part number		A-5003-5225	A-5003-5226	A-5003-5227
A	Ball dia. mm (in.)	0.3 (0.012)	0.5 (0.020)	0.7 (0.028)
B	Length mm (in.)	50.0 (1.97)	50.0 (1.97)	50.0 (1.97)
C	Stem dia. mm (in.)	0.2 (0.008)	0.4 (0.016)	0.5 (0.020)
D	EWL* mm (in.)	3.0 (0.12)	4.0 (0.16)	5.0 (0.20)
	Mass grammes	15.79	15.79	15.79

50 mm range

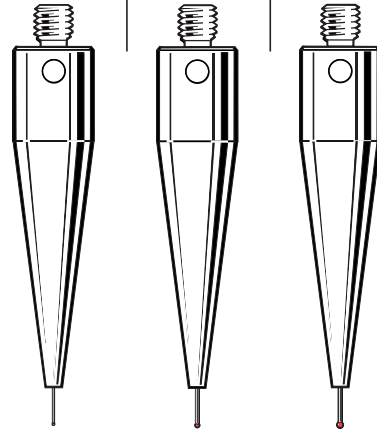

A-5003-5240	A-5003-5241	A-5003-5242
0.3 (0.012)	0.5 (0.020)	0.7 (0.028)
75.0 (2.96)	75.0 (2.96)	75.0 (2.96)
0.2 (0.008)	0.4 (0.016)	0.5 (0.020)
3.0 (0.12)	4.0 (0.16)	5.0 (0.20)
23.84	23.84	23.84

75 mm range

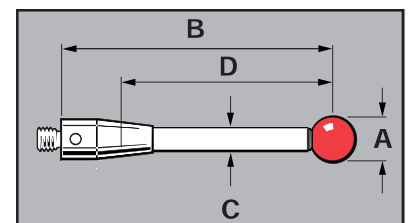
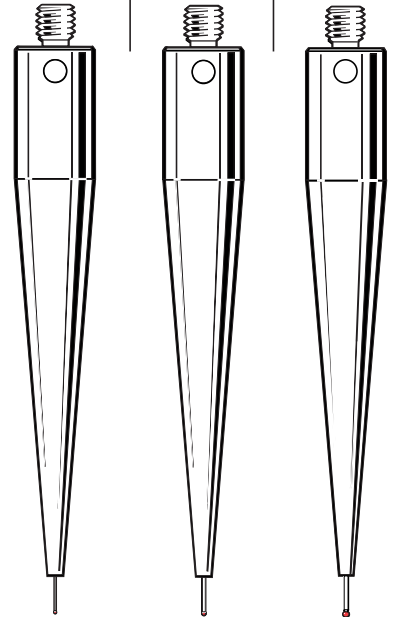

Ruby ball styli (tungsten carbide stems)

Ball material		Part number						
Ruby		A-5003-5204	A-5003-5205	A-5003-5206	A-5003-5207	A-5003-5208	A-5003-5209	A-5003-5210
Silicon nitride				A-5003-5732			A-5003-5733	
Zirconia				A-5003-5746			A-5003-5747	
A	Ball dia. mm (in.)	1.0 (0.04)	1.5 (0.06)	2.0 (0.08)	2.5 (0.10)	3.0 (0.12)	4.0 (0.16)	5.0 (0.20)
B	Length mm (in.)	20.0 (0.79)	20.0 (0.79)	20.0 (0.79)	20.0 (0.79)	20.0 (0.79)	20.0 (0.79)	20.0 (0.79)
C	Stem dia. mm (in.)	0.7 (0.028)	1.0 (0.04)	1.0 (0.04)	1.5 (0.06)	2.0 (0.08)	2.0 (0.08)	3.0 (0.12)
D	EWL* mm (in.)	5.0 (0.20)	11.0 (0.44)	11.0 (0.44)	11.0 (0.44)	11.0 (0.44)	11.9 (0.47)	11.5 (0.45)
	Mass grammes	6.52	4.68	4.70	4.84	5.12	5.19	6.06

20 mm range

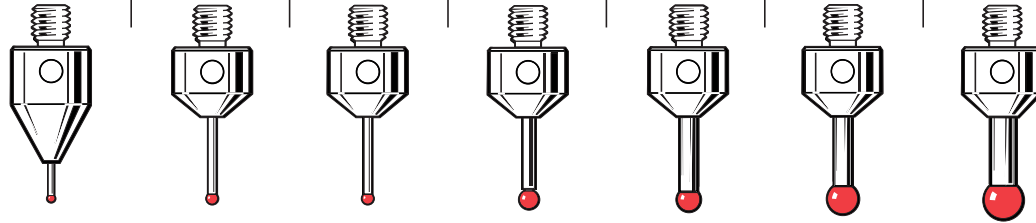

Part number		A-5003-5214	A-5003-5215	A-5003-5216	A-5003-5217	A-5003-5218	A-5003-5219	A-5003-5220
A	Ball dia. mm (in.)	1.0 (0.04)	1.5 (0.06)	2.0 (0.08)	2.5 (0.10)	3.0 (0.12)	4.0 (0.16)	5.0 (0.20)
B	Length mm (in.)	30.0 (1.19)	30.0 (1.19)	30.0 (1.19)	30.0 (1.19)	30.0 (1.19)	30.0 (1.19)	30.0 (1.19)
C	Stem dia. mm (in.)	0.7 (0.028)	1.0 (0.04)	1.0 (0.04)	1.5 (0.06)	2.0 (0.08)	2.0 (0.08)	3.0 (0.12)
D	EWL* mm (in.)	5.0 (0.20)	12.0 (0.48)	21.0 (0.83)	21.0 (0.83)	21.0 (0.83)	21.9 (0.86)	21.5 (0.85)
	Mass grammes	9.01	7.28	4.81	5.14	5.58	5.64	7.10

30 mm range

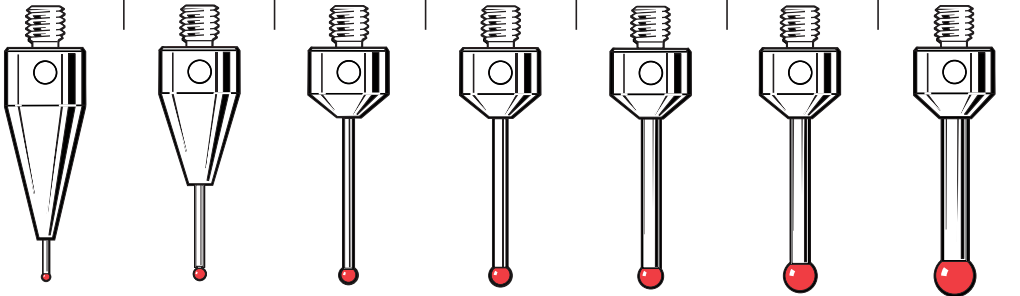

Part number		A-5003-5221	A-5003-5222	A-5003-5223	A-5003-5224
A	Ball dia. mm (in.)	1.5 (0.06)	2.0 (0.08)	2.5 (0.10)	3.0 (0.12)
B	Length mm (in.)	40.0 (1.58)	40.0 (1.58)	40.0 (1.58)	40.0 (1.58)
C	Stem dia. mm (in.)	1.0 (0.04)	1.0 (0.04)	1.5 (0.06)	2.0 (0.08)
D	EWL* mm (in.)	22.0 (0.87)	31.0 (1.23)	31.0 (1.23)	31.0 (1.23)
	Mass grammes	7.39	4.93	5.40	6.04

40 mm range

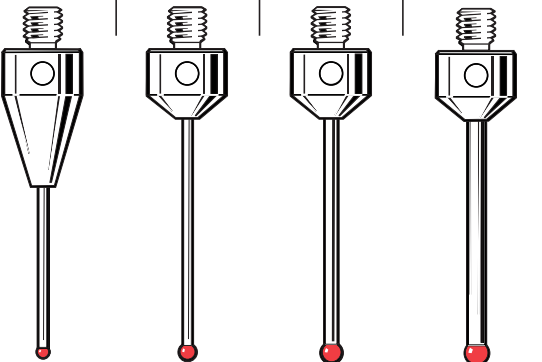

*Effective working length

Ruby ball styli (tungsten carbide stems – <5 mm ball diameter)

Part number	A-5003-5228	A-5003-5229	A-5003-5230	A-5003-5231	A-5003-5233	A-5003-5232	A-5003-5234	A-5003-5235
A Ball dia. mm (in.)	1.0 (0.04)	1.5 (0.06)	2.0 (0.08)	2.0 (0.08)	2.5 (0.10)	2.5 (0.10)	3.0 (0.12)	4.0 (0.16)
B Length mm (in.)	50.0 (1.97)	50.0 (1.97)	50.0 (1.97)	50.0 (1.97)	50.0 (1.97)	50.0 (1.97)	50.0 (1.97)	50.0 (1.97)
C Stem dia. mm (in.)	0.7 (0.028)	1.0 (0.04)	1.0 (0.04)	1.0 (0.04)	1.5 (0.06)	2.0 (0.08)	2.0 (0.08)	2.0 (0.08)
D EWL* mm (in.)	5.0 (0.20)	5.0 (0.20)	41.0 (1.62)	5.0 (0.20)	5.0 (0.20)	41.0 (1.62)	41.0 (1.62)	41.9 (1.65)
Mass grammes	15.81	14.82	5.05	14.85	14.94	6.48	6.50	6.55

50 mm range

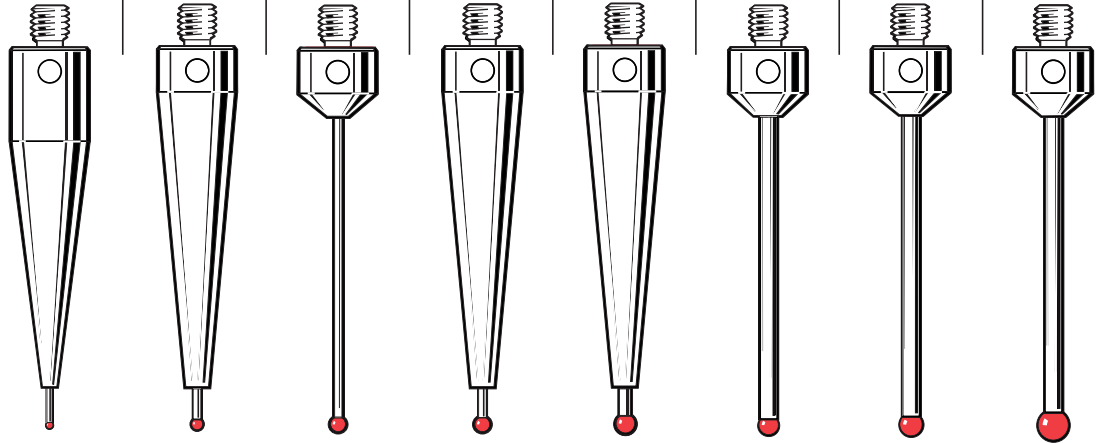

Ruby ball styli (≥5 mm ball diameter)

Ball material	Part number			
Ruby	A-5003-5236	A-5003-5237	A-5003-5238	A-5003-5239
Silicon nitride		A-5003-5734		
Zirconia			A-5003-5748	
	Tungsten carbide	Carbon fibre	Carbon fibre	Carbon fibre
A Ball dia. mm (in.)	5.0 (0.20)	6.0 (0.24)	8.0 (0.32)	10.0 (0.40)
B Length mm (in.)	50.0 (1.97)	50.0 (1.97)	50.0 (1.97)	50.0 (1.97)
C Stem dia. mm (in.)	3.0 (0.12)	4.0 (0.16)	6.0 (0.24)	6.0 (0.24)
D EWL* mm (in.)	41.5 (1.63)	39.5 (1.55)	39.5 (1.55)	44.5 (1.75)
Mass grammes	9.19	6.10	7.96	8.91

50 mm range

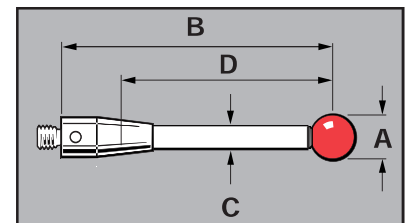
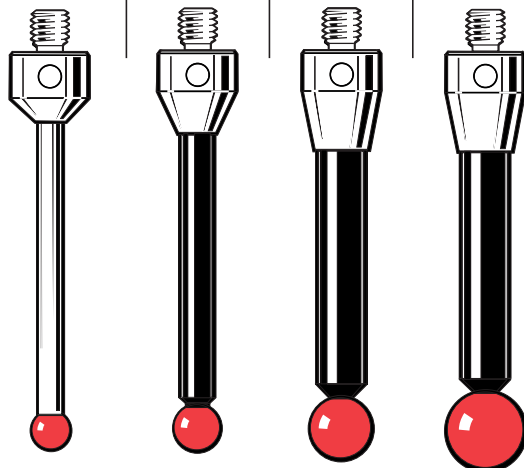

Ruby ball styli (1 mm – 10 mm ball diameter)

Part number		A-5003-5243	A-5003-5244	A-5003-5248	A-5003-5249	A-5003-5250	A-5003-5251	A-5003-5252
		Tungsten carbide	Tungsten carbide	Tungsten carbide	Tungsten carbide	Carbon fibre	Carbon fibre	Carbon fibre
A	Ball dia. mm (in.)	1.0 (0.04)	1.5 (0.06)	4.0 (0.16)	5.0 (0.20)	6.0 (0.24)	8.0 (0.32)	10.0 (0.40)
B	Length mm (in.)	75.0 (2.96)	75.0 (2.96)	75.0 (2.96)	75.0 (2.96)	75.0 (2.96)	75.0 (2.96)	75.0 (2.96)
C	Stem dia. mm (in.)	0.7 (0.028)	1.0 (0.04)	3.0 (0.12)	3.0 (0.12)	4.0 (0.16)	6.0 (0.24)	6.0 (0.24)
D	EWL* mm (in.)	5.0 (0.20)	5.0 (0.20)	66.0 (2.60)	66.0 (2.60)	65.1 (2.56)	64.5 (2.54)	69.5 (2.74)
	Mass grammes	23.86	23.90	11.61	11.80	6.59	9.06	10.01

75 mm range

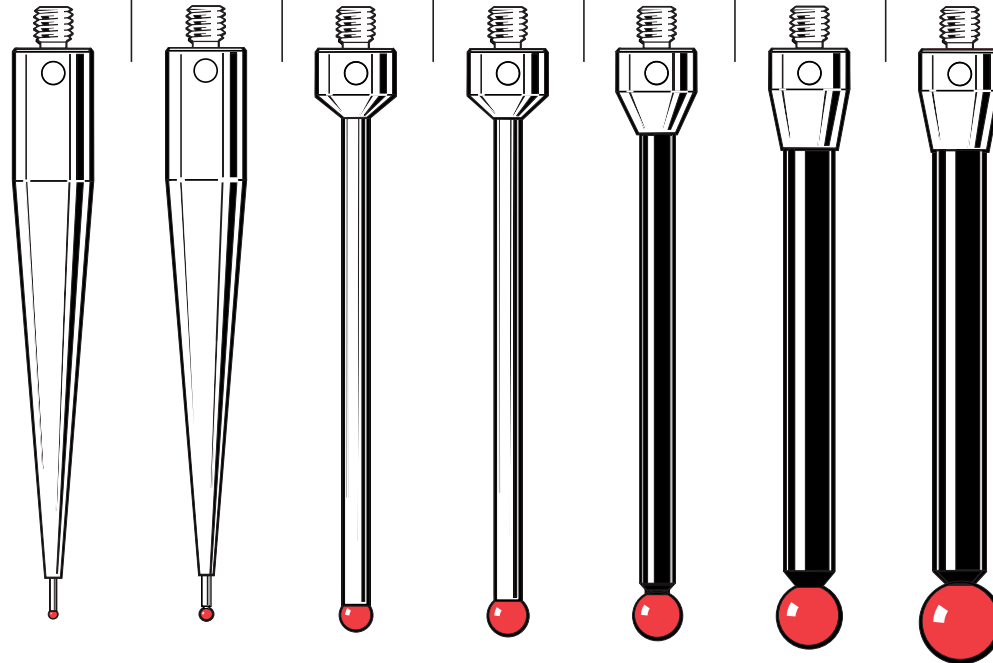

M5 threaded
stylus range

6.5

*Effective working length

Styli and accessories

Ruby ball styli (≤ 50 mm EWL)

M5 threaded
stylus range

6.6

Ball material		Part number				
Ruby		A-5003-5253	A-5003-5255	A-5003-5256	A-5003-5257	A-5003-5261
Silicon nitride						
Zirconia						
		Tungsten carbide	Tungsten carbide	Tungsten carbide	Tungsten carbide	Carbon fibre
A	Ball dia. mm (in.)	3.0 (0.12)	4.0 (0.16)	4.0 (0.16)	5.0 (0.20)	8.0 (0.32)
B	Length mm (in.)	100.0 (3.94)	100.0 (3.94)	100.0 (3.94)	100.0 (3.94)	100.0 (3.94)
C	Stem dia. mm (in.)	2.0 (0.08)	2.0 (0.08)	3.0 (0.12)	3.0 (0.12)	6.0 (0.24)
D	EWL* mm (in.)	20.0 (0.79)	30.5 (1.20)	50.0 (1.97)	50.0 (1.97)	50.0 (1.97)
	Mass grammes	25.71	25.75	23.07	23.31	22.97

100 mm range

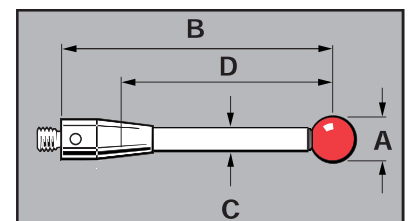
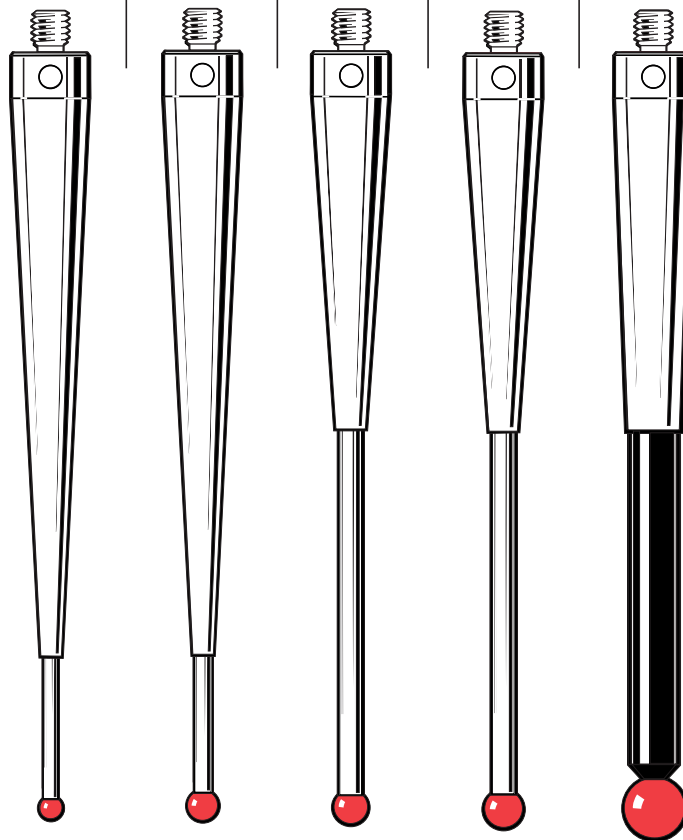

Ruby ball styli (>50 mm EWL)

Ball material		Part number						
Ruby Silicon nitride Zirconia		A-5003-5254	A-5003-5258	A-5003-5259 A-5003-5735 A-5003-5749	A-5003-5260	A-5003-5262	A-5003-5264	A-5003-5263
		Tungsten carbide	Tungsten carbide	Carbon fibre	Carbon fibre	Carbon fibre	Carbon fibre	Carbon fibre
A	Ball dia. mm (in.)	3.0 (0.12)	5.0 (0.20)	6.0 (0.24)	6.0 (0.24)	8.0 (0.32)	10.0 (0.40)	10.0 (0.40)
B	Length mm (in.)	100.0 (3.94)	100.0 (3.94)	100.0 (3.94)	100.0 (3.94)	100.0 (3.94)	100.0 (3.94)	100.0 (3.94)
C	Stem dia. mm (in.)	1.5 (0.06)	3.0 (0.12)	4.0 (0.16)	4.0 (0.16)	6.0 (0.24)	6.0 (0.24)	6.0 (0.24)
D	EWL* mm (in.)	55.0 (2.17)	91.0 (3.59)	58.9 (2.32)	90.1 (3.55)	89.5 (3.52)	94.5 (3.72)	95.5 (3.76)
	Mass grammes	16.30	14.40	19.66	7.08	10.17	11.11	23.91

100 mm range

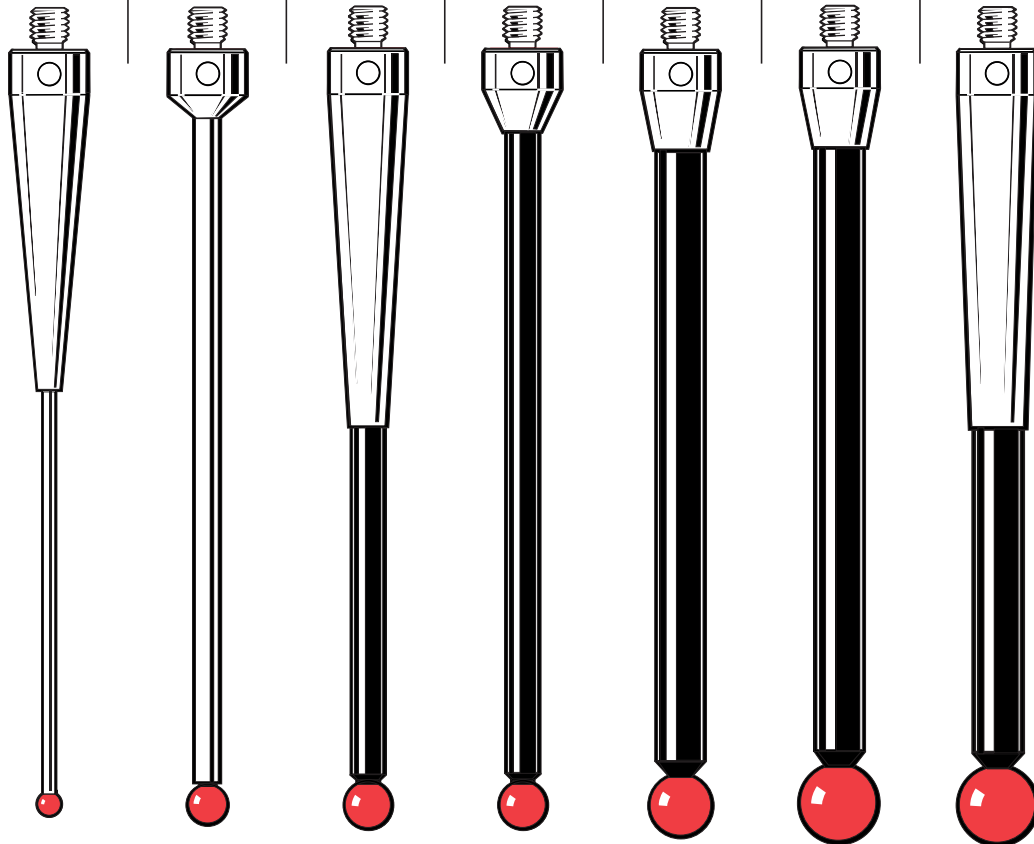

Styli and accessories

Ruby ball styli (carbon fibre stems)

M5 threaded
stylus range

6.8

Part number	A-5003-5265	A-5003-5266	A-5003-5267
A Ball dia. mm (in.)	6.0 (0.24)	8.0 (0.32)	10.0 (0.40)
B Length mm (in.)	150.0 (5.91)	150.0 (5.91)	150.0 (5.91)
C Stem dia. mm (in.)	4.0 (0.16)	6.0 (0.24)	6.0 (0.24)
D EWL* mm (in.)	137.0 (5.39)	135.0 (5.31)	144.5 (5.69)
Mass grammes	9.09	13.71	14.66

150 mm range

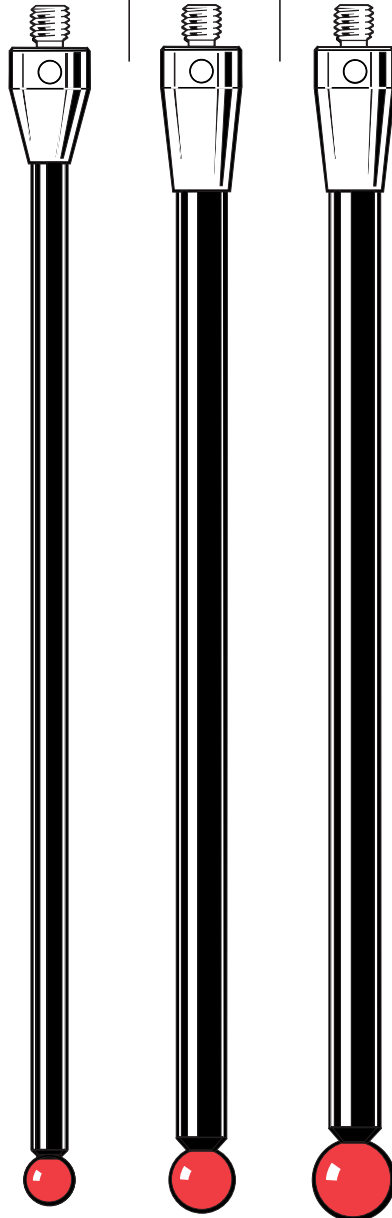

A-5003-5268	A-5003-5269	A-5003-5270
6.0 (0.24)	8.0 (0.32)	10.0 (0.40)
200.0 (7.88)	200.0 (7.88)	200.0 (7.88)
4.0 (0.16)	6.0 (0.24)	6.0 (0.24)
187.0 (7.36)	180.0 (7.09)	194.5 (7.66)
10.07	15.92	16.87

200 mm range

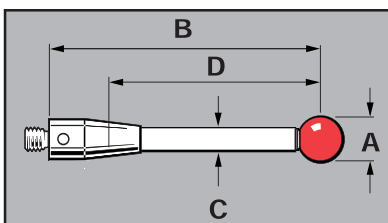
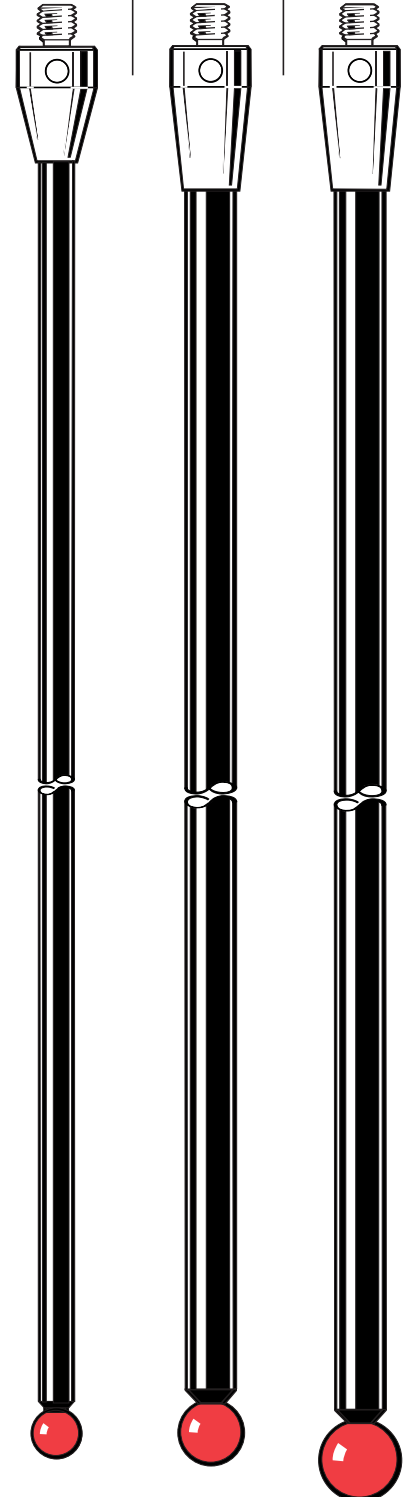

Ruby ball styli (carbon fibre stems)

Part number	A-5003-5271	A-5003-5272	A-5003-5273
A Ball dia. mm (in.)	6.0 (0.24)	8.0 (0.32)	10.0 (0.40)
B Length mm (in.)	300.0 (11.82)	300.0 (11.82)	300.0 (11.82)
C Stem dia. mm (in.)	4.0 (0.16)	6.0 (0.24)	6.0 (0.24)
D EWL* mm (in.)	287.0 (11.30)	280.0 (11.03)	294.5 (11.59)
Mass grammes	12.02	20.33	21.28

300 mm range

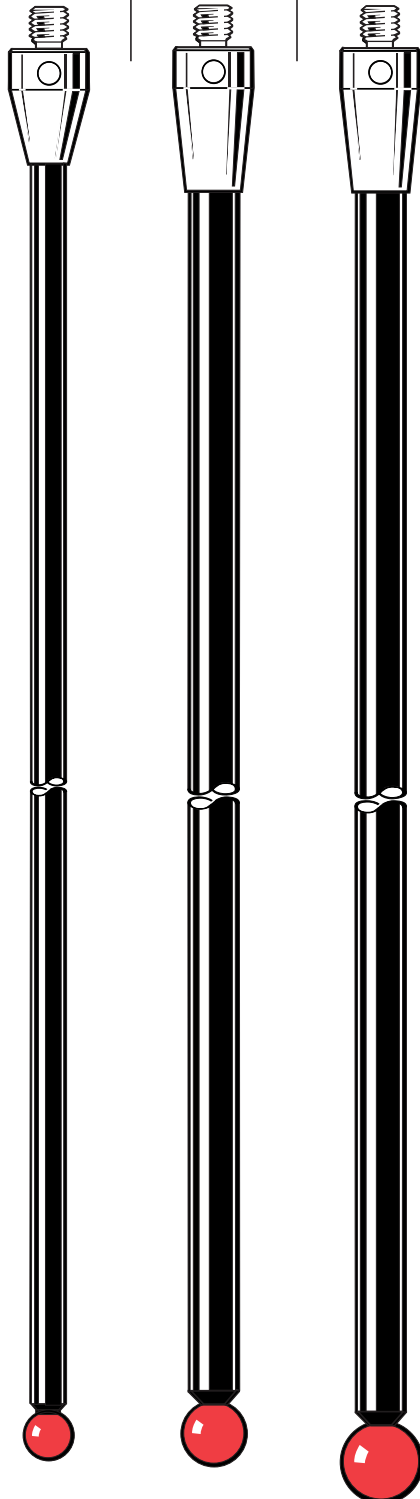

M5 threaded
stylus range

6.9

* Effective working length

Styli and accessories

Stylus extensions – thermo stable carbon fibre stems, titanium ends (stem dia. 11 mm)

Part number	A-5555-0647	A-5555-0648	A-5555-0649	A-5555-0623	A-5555-0650	A-5555-0651	A-5555-0652
Length mm (in.)	40.0 (1.58)	50.0 (1.97)	60.0 (2.37)	70.0 (2.76)	80.0 (3.15)	90.0 (3.55)	100.0 (3.94)
Stem dia. mm (in.)	11.0 (0.44)	11.0 (0.44)	11.0 (0.44)	11.0 (0.44)	11.0 (0.44)	11.0 (0.44)	11.0 (0.44)
Mass grammes	7.6	8.3	9.0	9.7	10.4	11.1	11.8

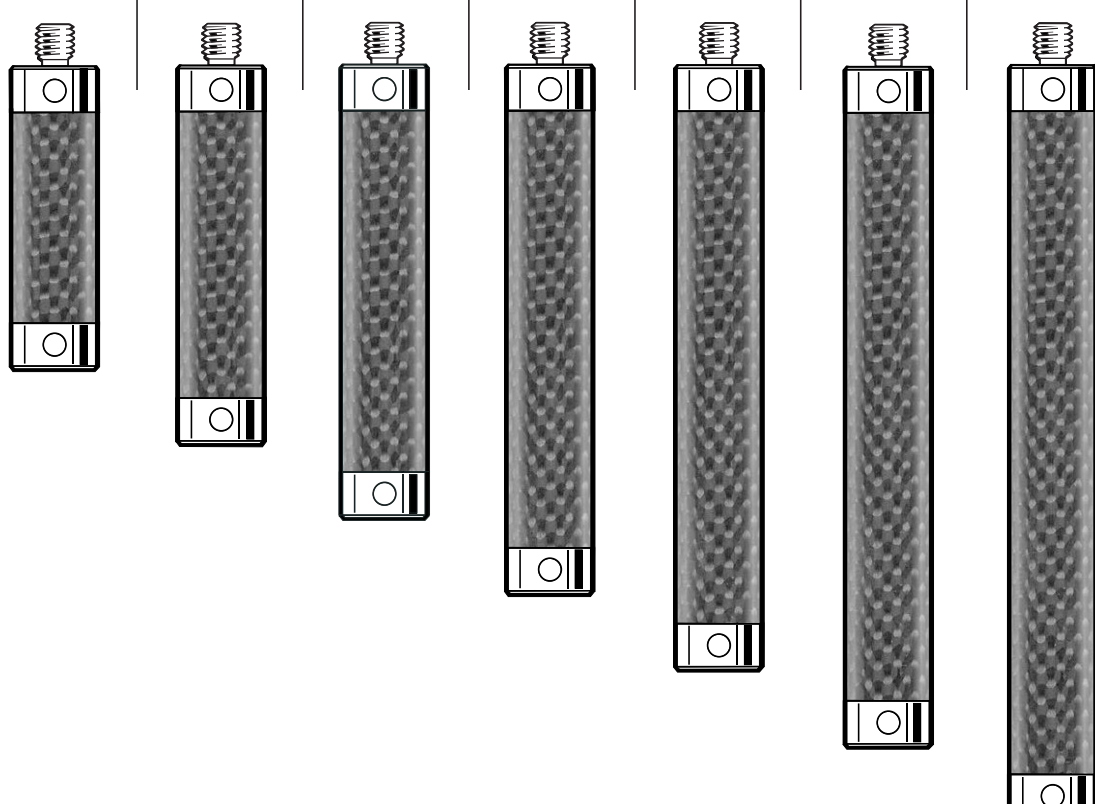

M5 threaded
stylus range

6.10

M5 extension tools

A-5003-6134

For M5 threaded extensions with
11 mm (0.44 in.) stem diameter

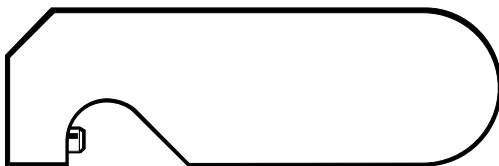

A-5003-6135

For M5 threaded extensions with
20 mm (0.79 in.) stem diameter

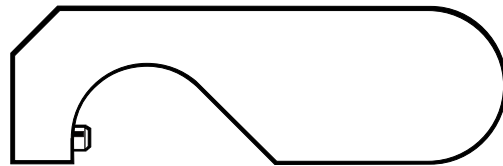

These tools are designed to fit styli extensions to Renishaw probes without causing internal damage

Stylus extensions – thermo stable carbon fibre stems, titanium ends (stem dia. 11 mm)

Part number	A-5555-0425	A-5555-0424	A-5555-0653	A-5555-0654	A-5555-0655	A-5555-0642	A-5555-0656
Length mm (in.)	120.0 (4.73)	150.0 (5.91)	180.0 (7.09)	200.0 (7.88)	250.0 (9.85)	300.0 (11.82)	400.0 (15.76)
Stem dia. mm (in.)	11.0 (0.44)	11.0 (0.44)	11.0 (0.44)	11.0 (0.44)	11.0 (0.44)	11.0 (0.44)	11.0 (0.44)
Mass grammes	13.2	15.4	17.5	18.9	22.4	25.9	33.0

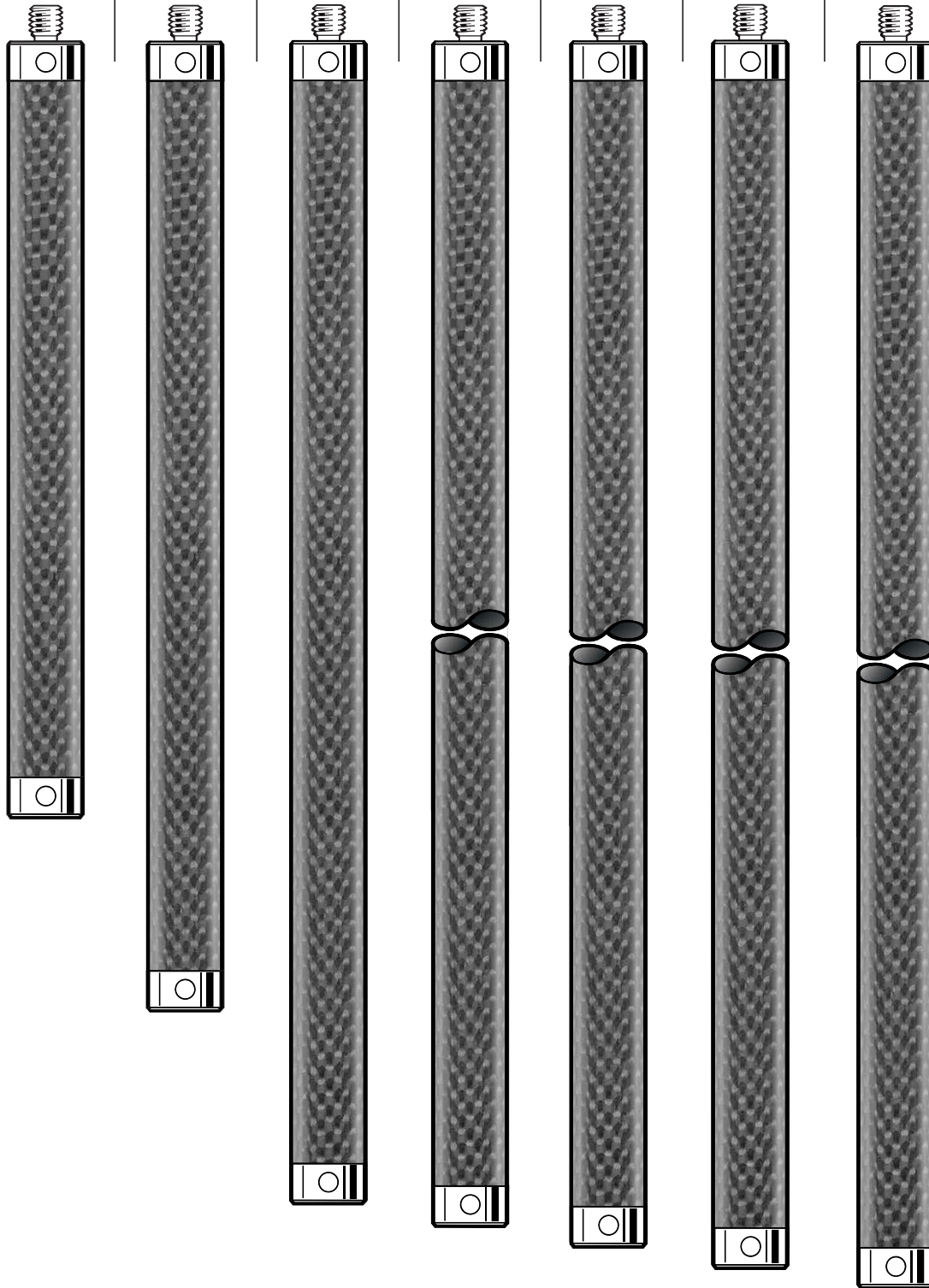

Stylus extensions – thermo stable carbon fibre stems, titanium ends (stem dia. 20 mm)

Part number	A-5555-0620	A-5555-0657	A-5555-0658	A-5555-0621	A-5555-0659	A-5555-0660	A-5555-0661
Length mm (in.)	40.0 (1.58)	50.0 (1.97)	60.0 (2.37)	80.0 (3.15)	100.0 (3.94)	120.0 (4.73)	150.0 (5.91)
Stem dia. mm (in.)	20.0 (0.79)	20.0 (0.79)	20.0 (0.79)	20.0 (0.79)	20.0 (0.79)	20.0 (0.79)	20.0 (0.79)
Mass grammes	23.8	25.1	26.5	29.3	32.1	34.9	39.0

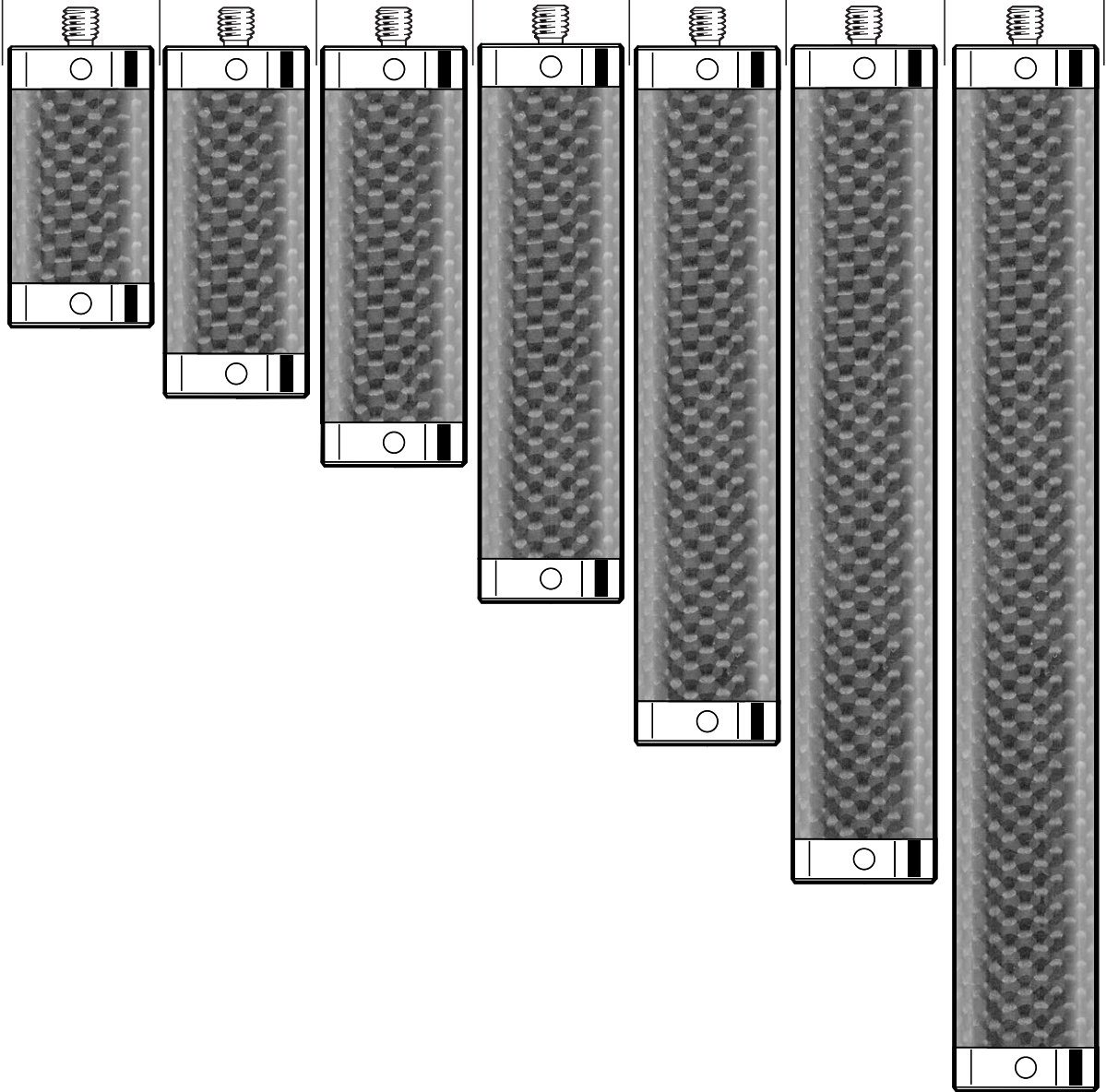

Stylus extensions – thermo stable carbon fibre stems, titanium ends (stem dia. 20 mm)

Part number	A-5555-0662	A-5555-0663	A-5555-0427	A-5555-0664	A-5555-0665	A-5555-0667	A-5555-0668
Length mm (in.)	180.0 (7.09)	200.0 (7.88)	250.0 (9.85)	300.0 (11.82)	400.0 (15.76)	500.0 (19.70)	600.0 (23.64)
Stem dia. mm (in.)	20.0 (0.79)	20.0 (0.79)	20.0 (0.79)	20.0 (0.79)	20.0 (0.79)	20.0 (0.79)	20.0 (0.79)
Mass grammes	43.2	46.0	52.9	59.9	73.8	87.7	101.5

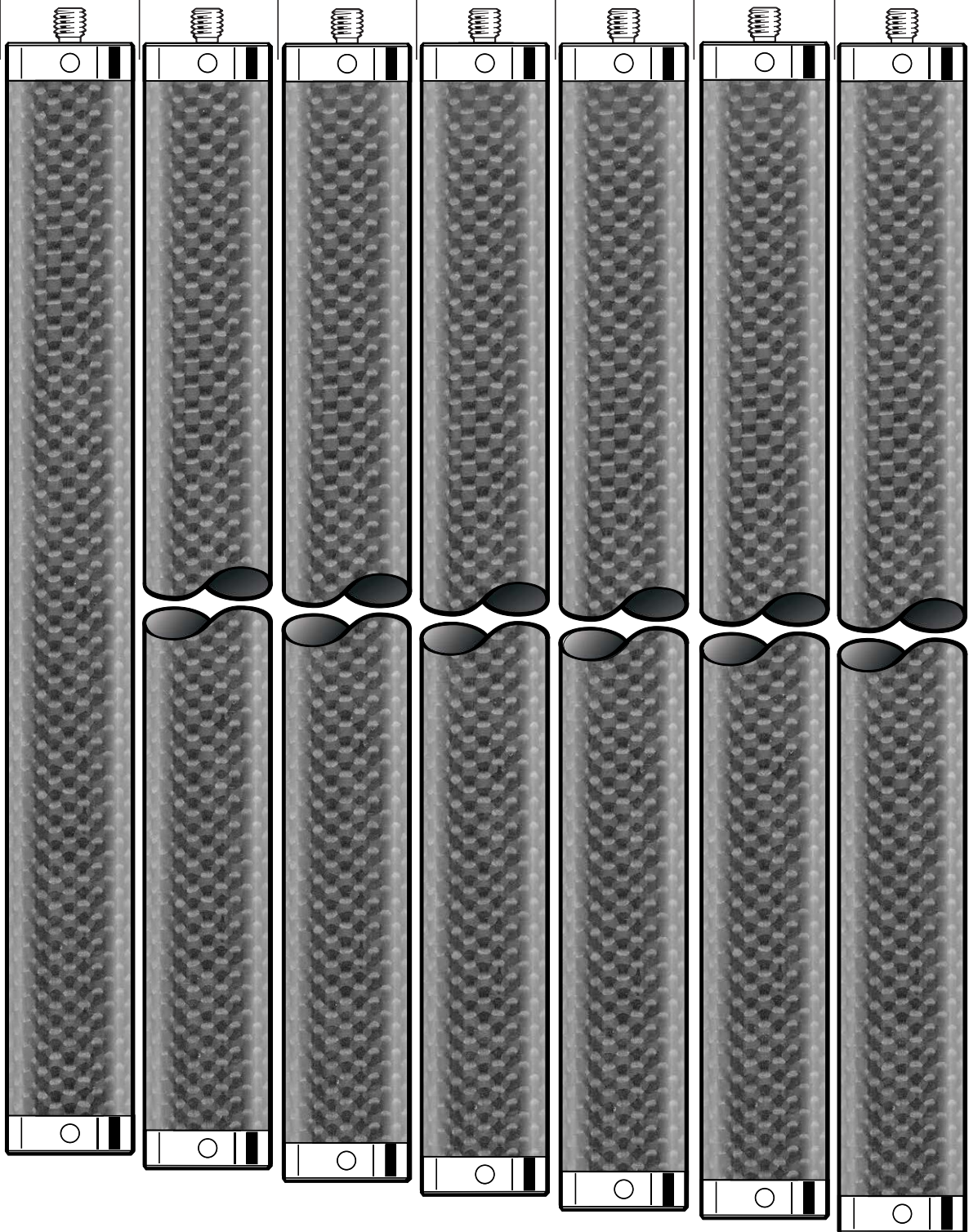

Styli and accessories

Stylus extensions – stainless steel

Part number	A-5555-0142	A-5555-0140	A-5555-0669	A-5555-0670	A-5555-0136
Length mm (in.)	10,0 (0,40)	20,0 (0,79)	30,0 (1,19)	50,0 (1,97)	100,0 (3,94)
Stem dia. mm (in.)	11,0 (0,44)	11,0 (0,44)	11,0 (0,44)	11,0 (0,44)	11,0 (0,44)
Mass grammes	6,0	13,0	20,0	34,8	73,0

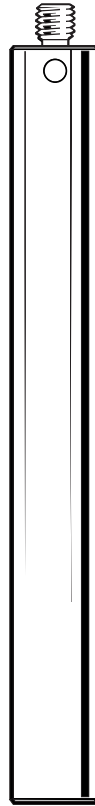
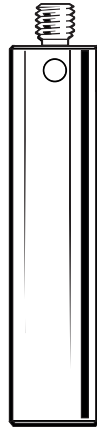
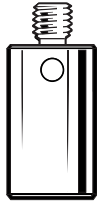
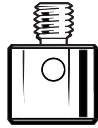

Stylus extensions – aluminium

Part number	A-5555-0671	A-5555-0127	A-5555-0125
Length mm (in.)	50.0 (1.97)	100.0 (3.94)	200.0 (7.88)
Stem dia. mm (in.)	20.0 (0.79)	20.0 (0.79)	20.0 (0.79)
Mass grammes	47.2	50.0	85.0

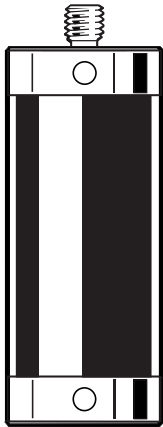

Styli and accessories

Disc styli – silver steel

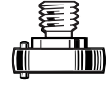
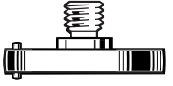
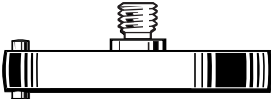
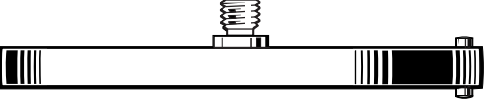
Part number	A-5003-5288	A-5003-5289	A-5003-5290	A-5003-5291
Disc dia. mm (in.)	12.0 (0.48)	21.0 (0.83)	35.0 (1.38)	63.5 (2.51)
Disc depth mm (in.)	3.0 (0.12)	3.0 (0.12)	5.0 (0.20)	5.0 (0.20)
Roller depth mm (in.)	5.0 (0.20)	5.0 (0.20)	8.0 (0.31)	8.0 (0.31)
Mass grammes	2.52	5.23	14.0	51.0
				

M5 threaded
stylus range

6.16

Hemispherical styli – ceramic

Part number	A-5003-5275	A-5003-5276	A-5003-5277
Ball dia. mm (in.)	16.0 (0.63)	22.0 (0.87)	30.0 (1.18)
Length mm (in.)	19.5 (0.77)	20.5 (0.81)	24.5 (0.96)
Mass grammes	7.0	14.0	19.7
	